

Scope of application



C5 combines a compact footprint with the natural reproduction and extraordinary SPL of far larger systems. In combination with a subwoofer like B10 or B14, C5 could be used as a small PA system in bars or restaurants. C5 lining the lip of the stage are suitable as discreet near-fills.

C5i should be used for applications with low and medium volume requirements where excellent sound and even dispersion are important. These include background sound reinforcement in bars, restaurants, shopping malls or small conference rooms. The C5i is also suitable for sound reinforcement over short distances in theatres, churches or houses of worship.

Technical Data

	C5:	C5i:
Components:	1× 5" LF compression driver, 1× 1" HF compression driver	1× 5" LF compression driver, 1× 0.7" HF dome-tweeter
Frequency response:	90 - 20000 Hz	100 - 22000 Hz
Power handling, (program/peak):	250/500W	100/200W
Impedance:	24 Ω	6 Ω
Sensitivity: 1W/1m:	91 dB	88 dB
SPLmax / 1m:	117 dB	111 dB
Weight:	3.9 kg [9 lbs]	2.4 kg [5.3 lbs]
	black type label, white font	white type label, black font

Amplifier suggestion

The higher impedance of the C5 speaker requires higher voltage capacities of the amplifier. C5 is capable to provide a high output power and sound pressure level. Several loudspeakers can be connected in parallel on one amplifier channel. TWAUDIO suggests a usage of C5 at power amplifiers with a maximum power capability of 1500W at 8 ohms per channel.

The speaker power handling of C5i is smaller in comparison to C5. A lower impedance makes the loudspeaker suitable for the usage on smaller standard amplifiers. TWAUDIO suggests a usage of C5i at power amplifiers with a maximum power capability of 150W at 8 ohms per channel. Furthermore, an additional limiter is suggested while using the speaker on a standard amplifier. Our support department provides more information regarding the required system settings. For optimum performance, TWAUDIO provides presets for the amplifier platforms of Powersoft and Lab.Gruppen.

TWAUDIO GmbH
Osterholzallee 140-1
71636 Ludwigsburg
Germany

Tel.: +49 7141 488989-0
Fax: +49 7141 488989-99
Mail: info@twaudio.com

Similarities

- » identical enclosure and grille
- » Coverage: 110° radial
- » Dimensions (H×W×D): 240×160×160 mm [9.45×6.3×6.3 in]
- » Protection class: IP54 rating achieved with WPC5 installation cover mounted.
- » Connection: 2× speakON®-socket NL4 1± and Terminal ±
- » Finish: Warnex texture paint
- » Options: RAL colours
- » Accessories: MKC5, WPC5, WHS, BagC5

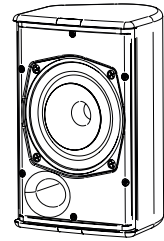

Technical Drawing

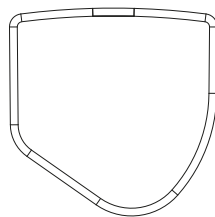

BOTTOM VIEW

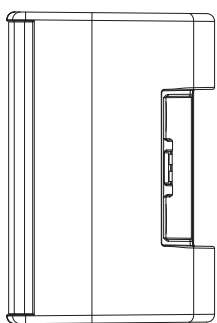

RIGHT VIEW

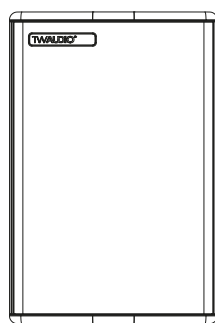

FRONT VIEW

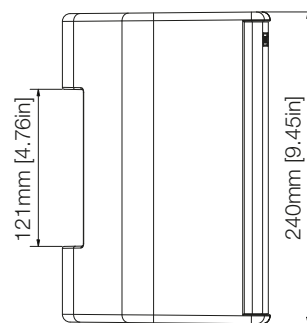

LEFT VIEW

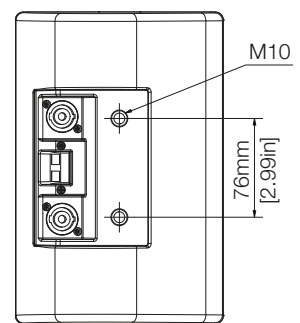

REAR VIEW

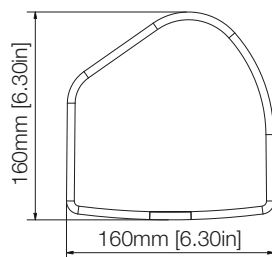

TOP VIEW