

bottom view

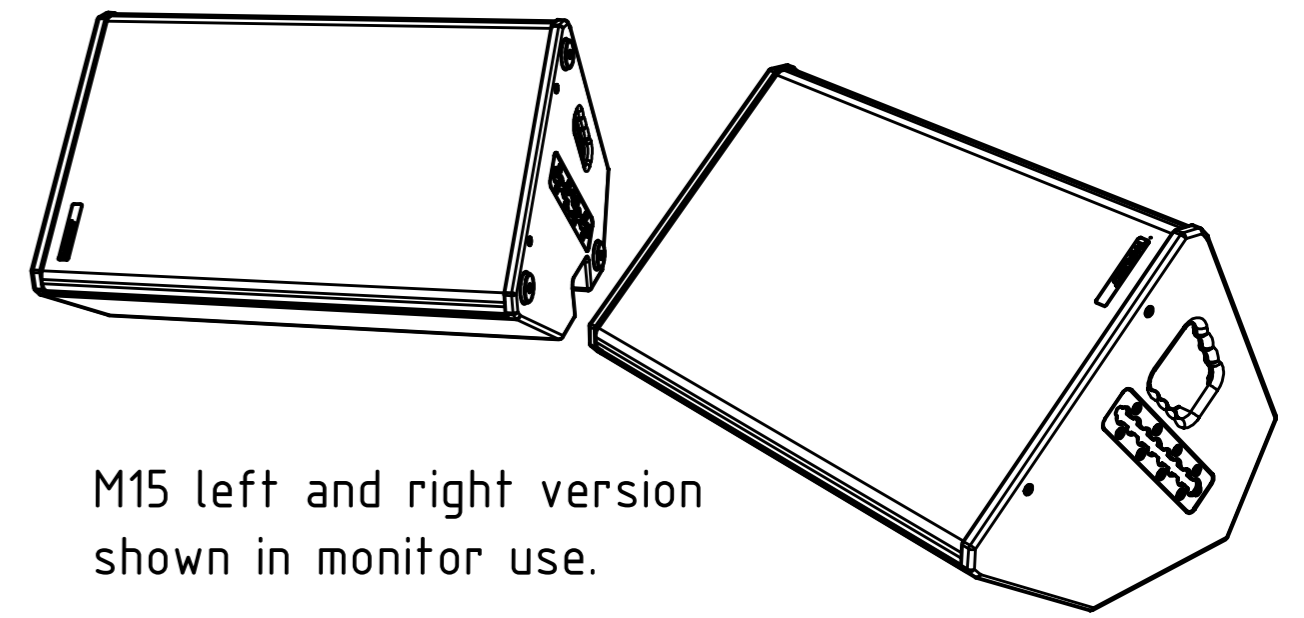

M15 left and right version shown in monitor use.

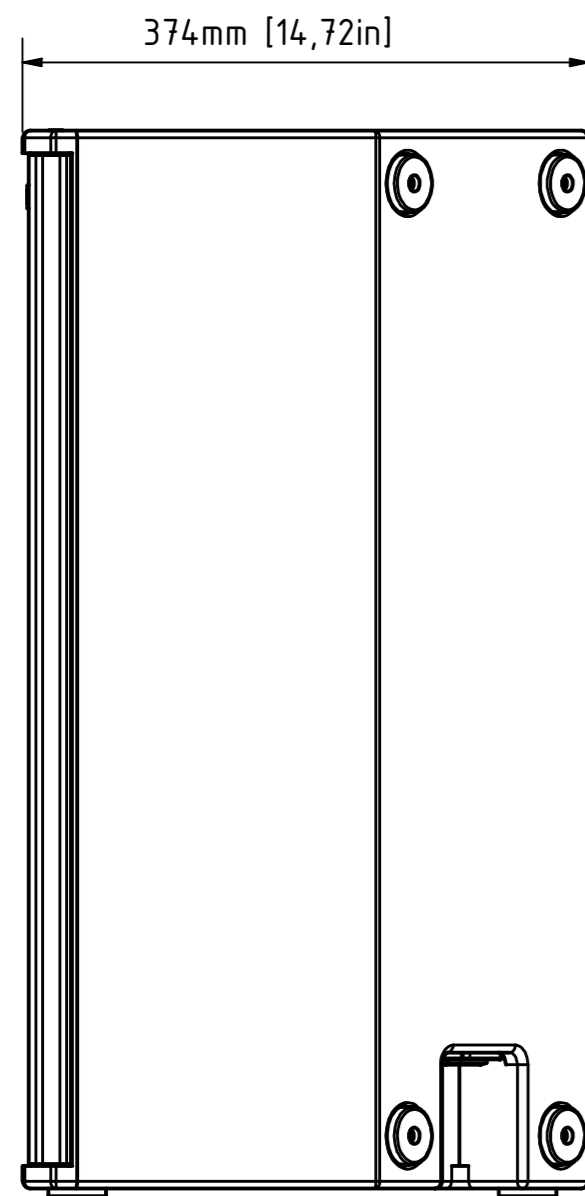

right view

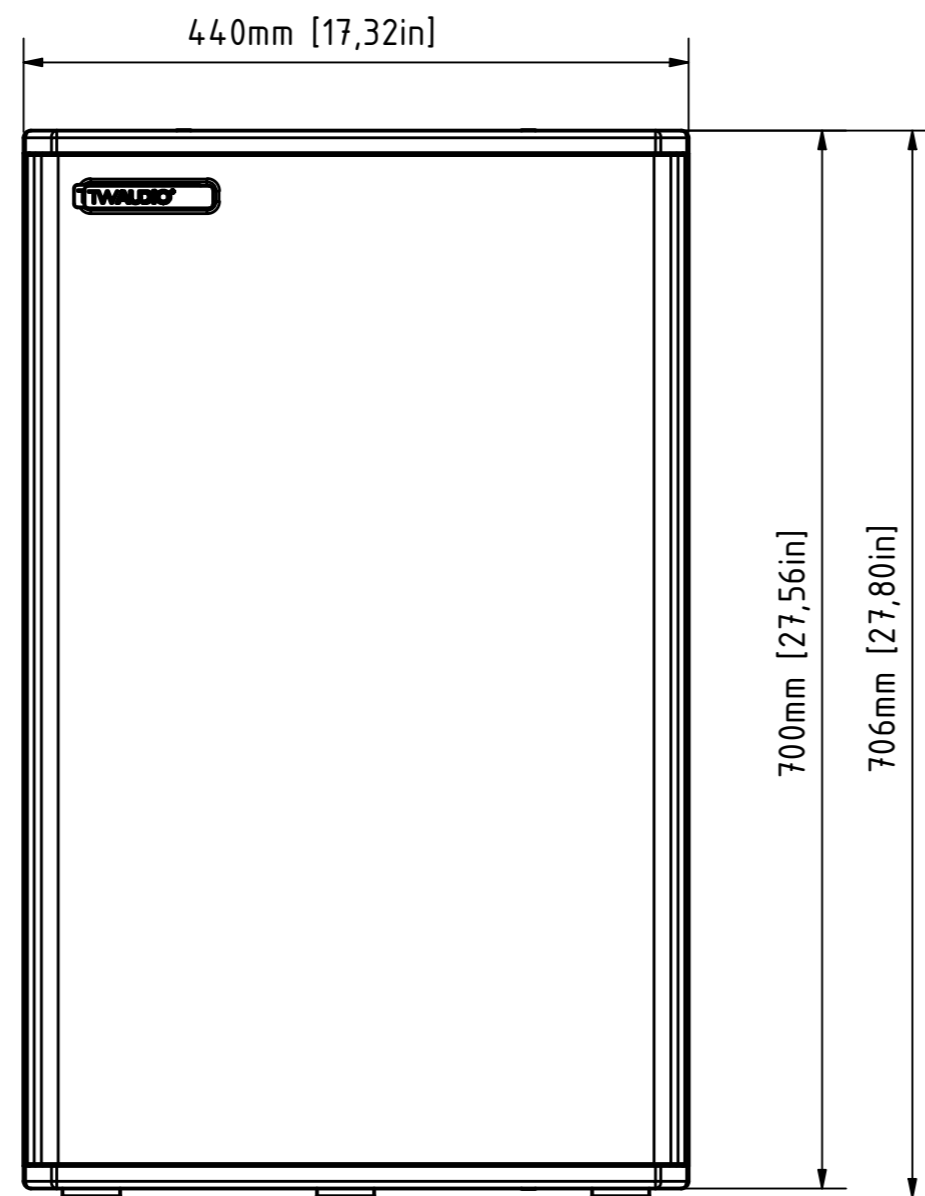

front view

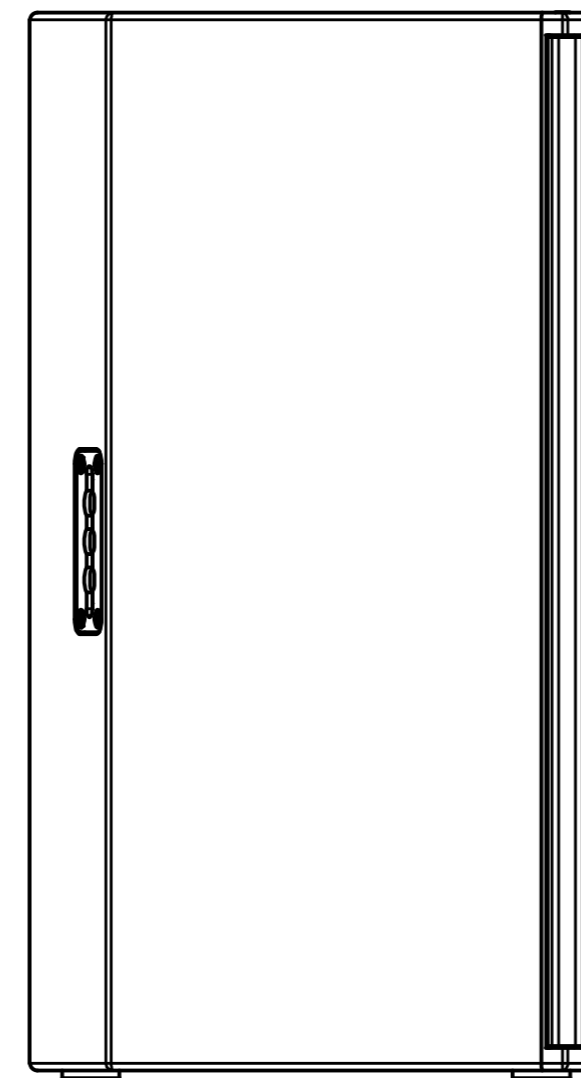

left view

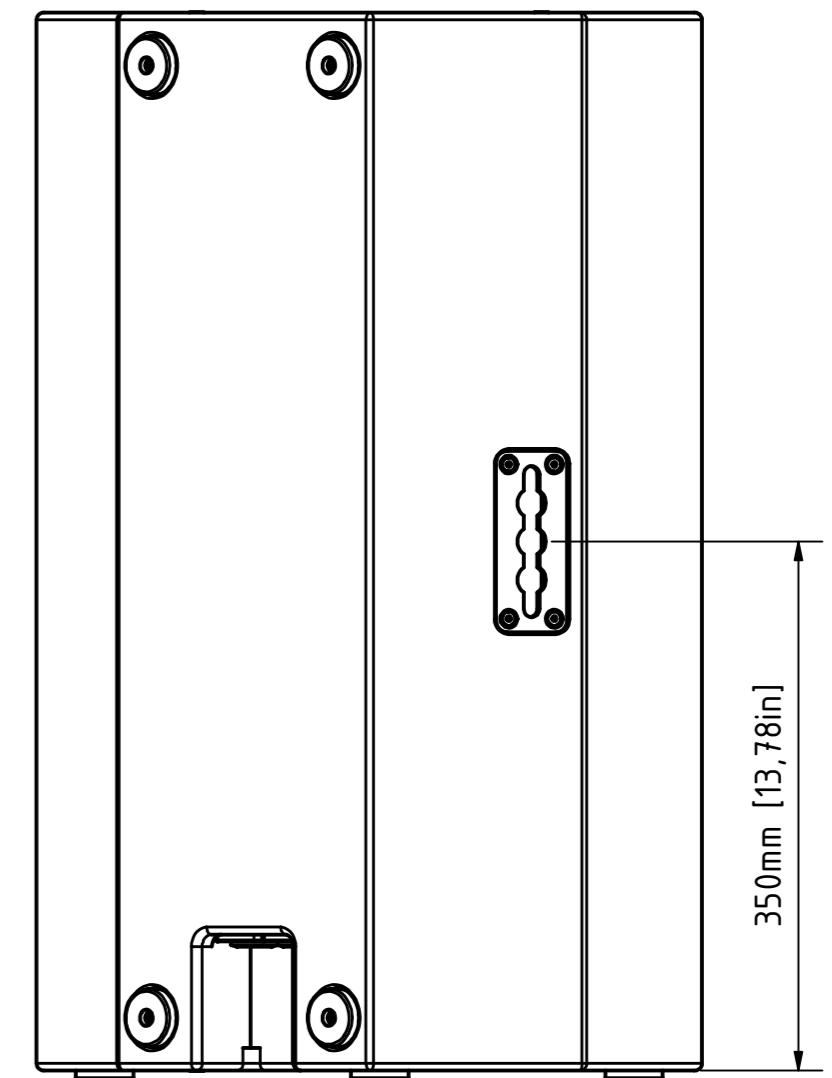

rear view

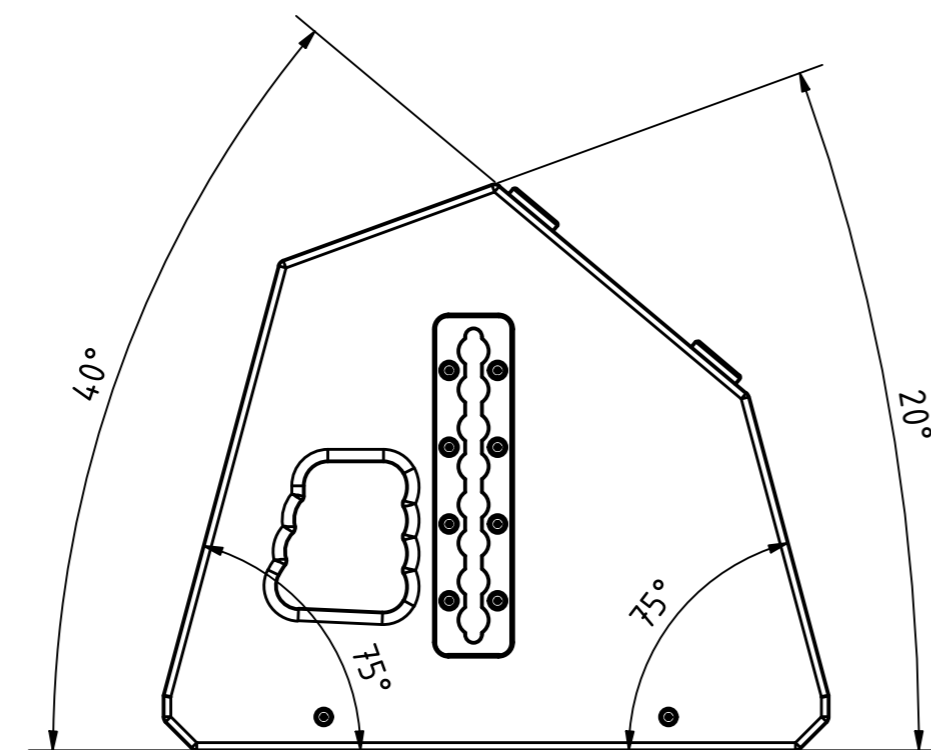
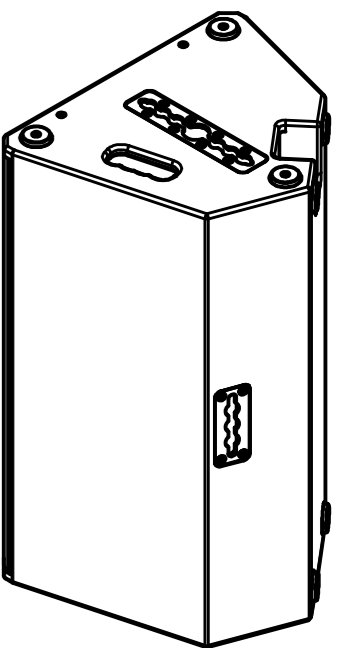

top view

1	Address modified	08.12.2021	Heike Konrad
rev. no.	description	date	modified by
revision process			
TWAUDIO Karl-Hofer-Str. 42 14163 Berlin www.twaudio.de		scale: weight: 24,9kg [55 lbs]	order number:
All rights to this drawing reserved in accordance with ISO 16016. Copying and distribution by manufacturer's permission only.		document type: overview drawing	type: M15
general tolerance ISO 2768-mK ISO 13920-BF ISO 9013-IIA/K according to ISO 8015		status type: released	drawing number: TWA-M15-0001
edges according to ISO 13715 surfaces (Ra) array 2 array 3 according to ISO 1302		date 18.11.2009 name Stefan Ullrich	revision no. sheet 1 1 Az
checked: approved: 08.12.2021 Heike Konrad		drawing number: TWA-M15-0001	
<small>©T/CAD TW AUDIO/CAD-Daten/Produkt/M15/M15_Ansordnung.lam</small>			