

TWVERiFY® NFC TAG

Position guide



Introduction

Thank you for choosing a high-quality product “MADE IN GERMANY” from the brand TWAUDIÖ.

TWAUDIÖ introduces TWERiFY®: NFC-based product verification in the fight against product piracy.

Start TWERiFY® – Against Counterfeiting

To ensure TWAUDIÖ customers and users the security of an original loudspeaker, we have developed a unique verification process in the industry: The result is TWERiFY®, the innovative NFC-based product verification process by TWAUDIÖ.

With a mobile phone and an internet connection, the simple and tamper-proof TWERiFY® process can be initiated, verifying each genuine TWAUDIÖ loudspeaker as an original.

Why to choose the TWAUDIÖ original:

Invisible yet present: Each original TWAUDIO loudspeaker, from production starting 01.01.2024, is equipped with an NFC chip hidden in the enclosure.

In this guide you will find the exact position of the NFC chip graphically shown on the individual speakers.

The exact position is shown as a black circle for the touring loudspeakers and as a black square for the install loudspeakers.

How TWERiFY® works:

1. Switch on your mobile device, and activate your Internet connection.

iOS: Apple iPhone models from iPhone 7, IOS 13.1 work without an extra NFC reader, older devices require an app to be installed and started.

Android: Be sure NFC reading is on. To turn this on, look for NFC at your quick settings, or go to Settings > Connected devices (or similar, depending on your device) > NFC and turn it on.

2. Unlock your device and hold it near the NFC chip's position.

If the chip is not recognized immediately, enlarge the search area around this very position.

3. As soon as the chip has been recognized, the TWERiFY® application shows a message on your screen.

Tap on this message to open your default browser and TWERiFY® will automatically start to confirm the authenticity of your product.

Touring loudspeaker

B-series

B10

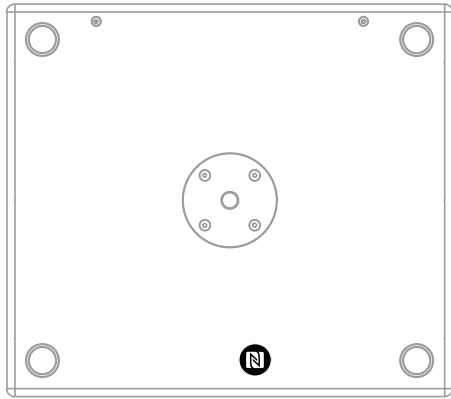

B14

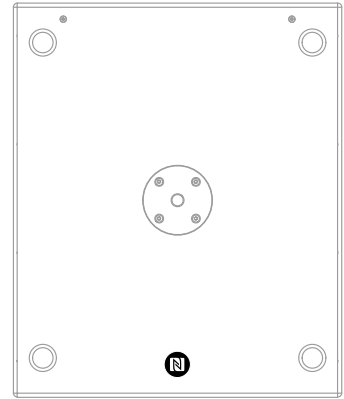

B15

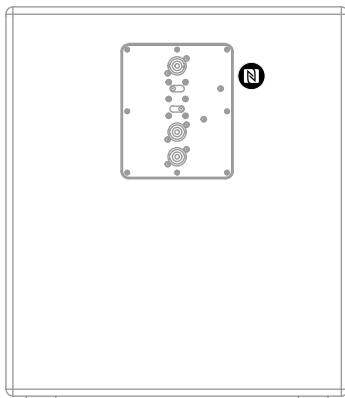

B18 / VERA S18

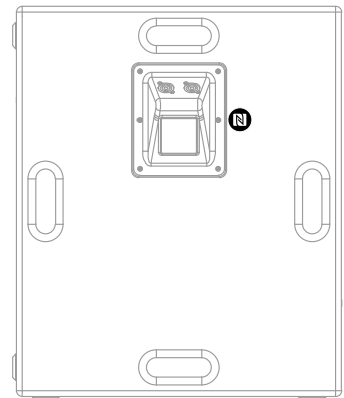

B30

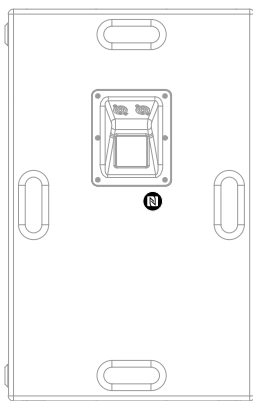

BSX

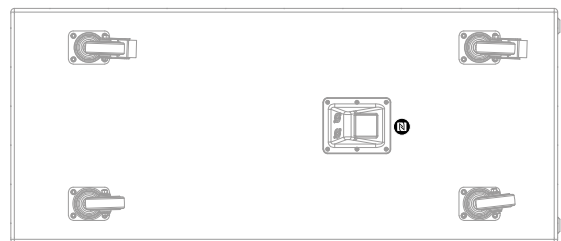

C-series / Ci-series

C5 / C5i

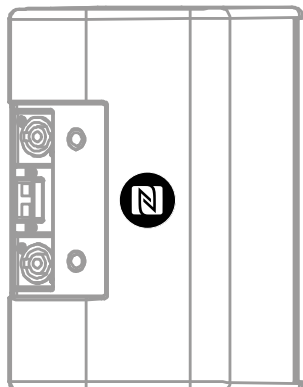

C12 / C15

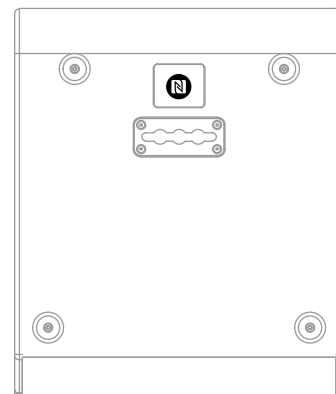

ELLA-series

ELLA6 / ELLA L18

Please note that the ELLA6 and the ELLA L18 look the same from above and below. You can find the NFC chip at the top of these loudspeakers.

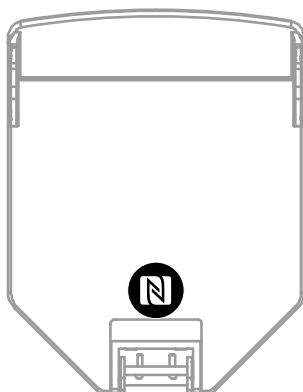

M-series

M6

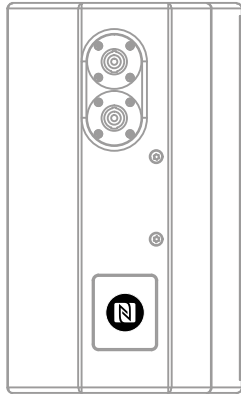

M8

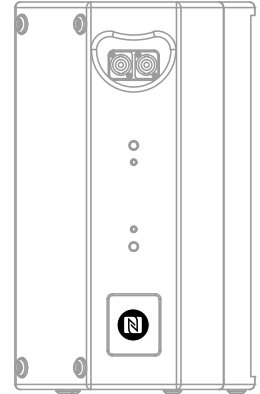

M10

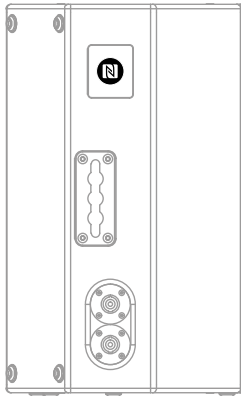

M12 / M15

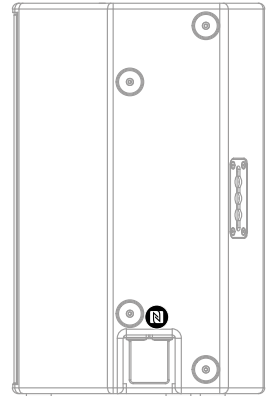

T-series

T20

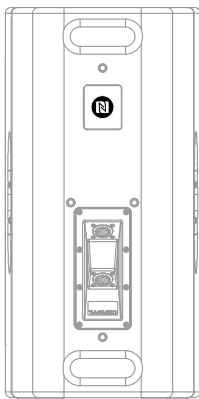

T24N

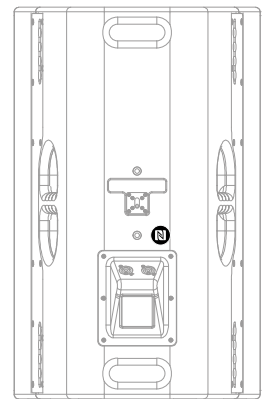

VERA10-series

VERA10

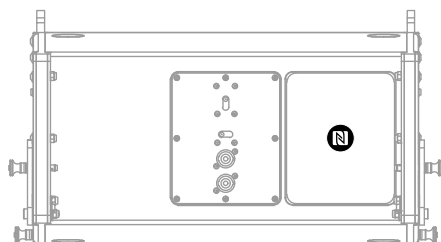

VERAL24

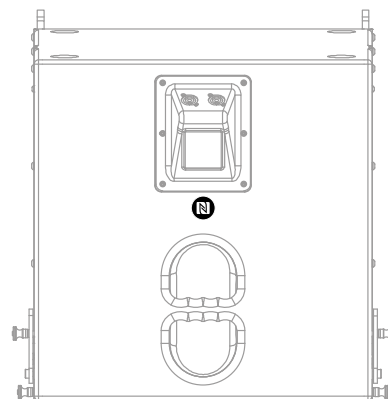

Please note that the NFC chip at the VERAS18 loudspeaker is at the same position as at the B18.

VERA20-series

VERA20

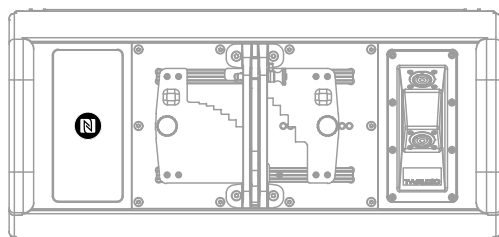

VERAS32

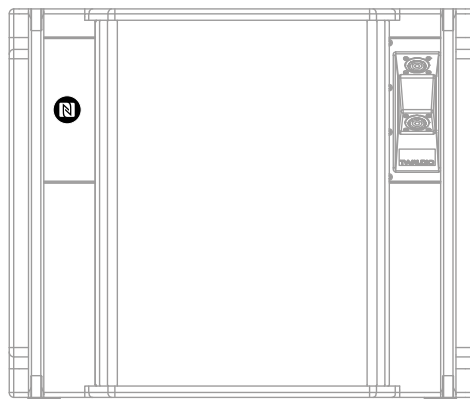

VERA36-series

VERA36

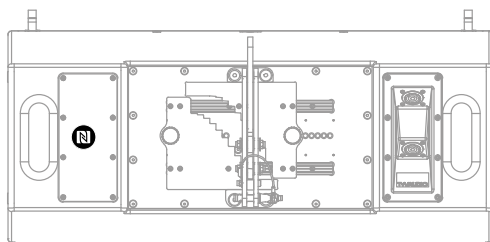

VERAS33

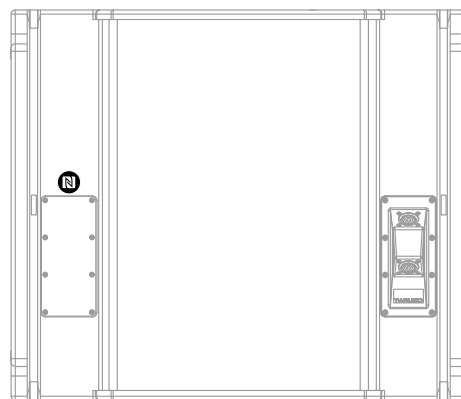

Install loudspeaker

All install loudspeakers:

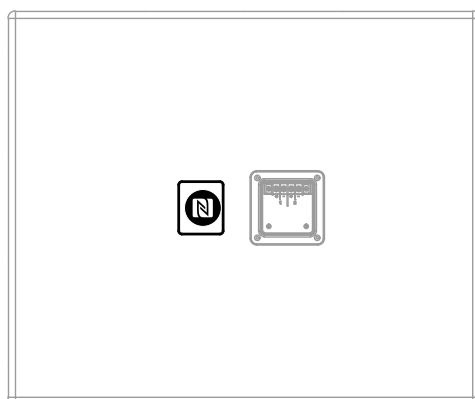

TW AUDiO INTERNATIONAL GmbH
Osterholzallee 140-2
71636 Ludwigsburg (Germany)

Phone: + 49 (0) 71 41-48 89 89 0

Fax: + 49 (0) 71 41-48 89 89 99

E-Mail: info@twaudio.de

WWW: www.twaudio.de

Position guide: PG-NFC TAG

Version 1.1 en, 02/2024

© by TW AUDiO 2024; all rights reserved.